

SUPPORT FOR OPENING (DOOR ETC)
P120*80

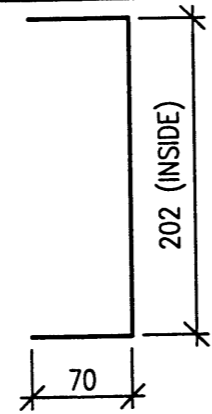

① STEEL SHEET 12 mm, PE-COATED
128 m

② ALUMINIUM 15 mm, PVF2-COATED
128 m

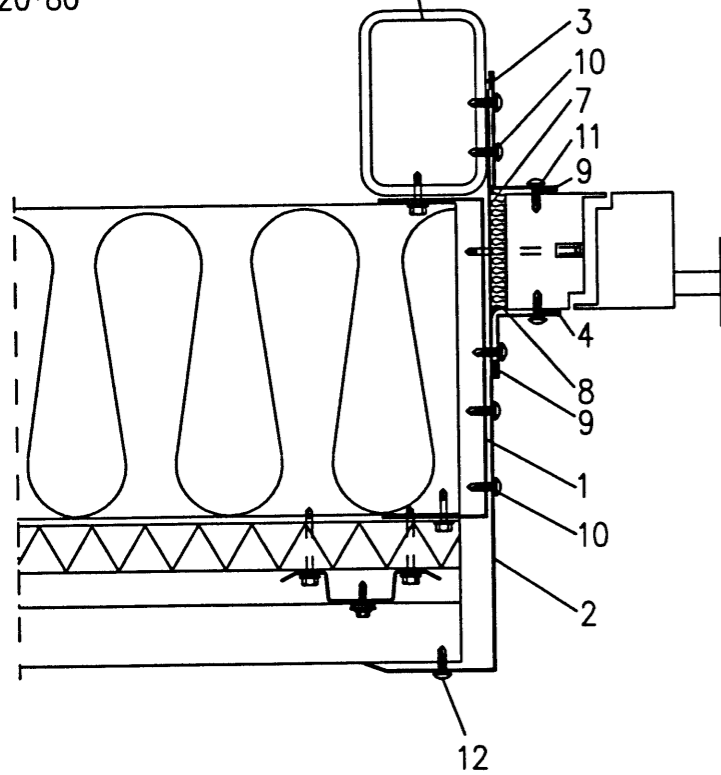
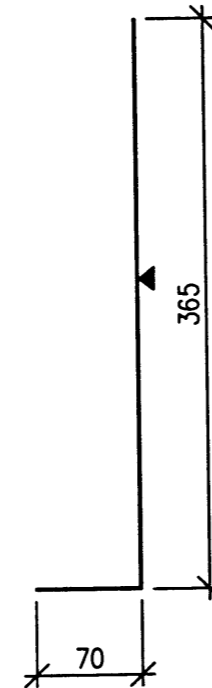

③ STEEL SHEET 12 mm, PE-COATED
153 m

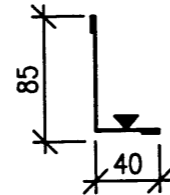

④ ALUMINIUM 12 mm, PVF2-COATED
153 m

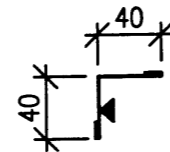

⑥ ALUMINIUM 12 mm, PVF2-COATED
25 m

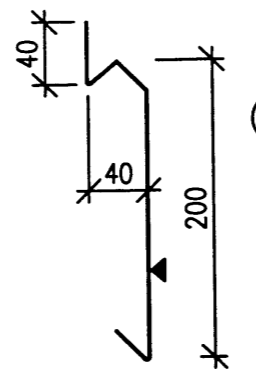

⑤ STEEL SHEET 12 mm, PE-COATED
25 m

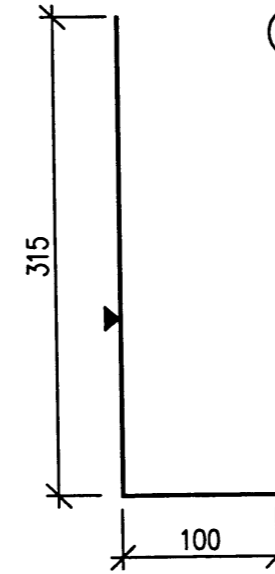

SAMÞYKKT AF BYGGINGARFULLTRUA

BYGGINGARFULLTRUINN I VESTMANNAEYJUM

1. STEEL SHEET t=12 mm, PE-COATED
2. ALUMINIUM 15 mm, PVF2-COATED
3. STEEL SHEET t=12 mm, PE-COATED
4. ALUMINIUM t=15 mm, PVF2-COATED
5. STEEL SHEET t=12 mm, PE-COATED
6. ALUMINIUM t=12 mm, PVF2-COATED
7. MINERAL WOOL
8. SEALING
9. SEALING
10. FASTENING SCREWS cc 400 mm, 1850 PCS
11. FASTENING SCREWS cc 400 mm, 500 PCS

REV No	REV MARK	REVISION DESCRIPTION	REVISION DATE
DRAWING TITLE		OPENINGS FOR DOORS	
CONTRACT		Rannila Steel Dy	
MODELLED BY		ISSUE DATE	06.11.2000
CONTRACT NO		SCALE	1/50

