



HRAUNTÚN 18.

VESTMANNAEYJUM

SKÝRINGAR:

JÁRNBENDING: UPPMÆÐ OG UNDIR GLUGGA OG HURÐAOP KOMI 2 \varnothing 12
 EN YFIR OP KOMI 3 \varnothing 12 NEMA ANNAÐ SÉ TEKIÐ FRAM. Í LÁRÉTT JÁRN NÁI 60.CM ÚTFYRIR OP EÐA SÉU SAMFELLD UM FLEIRI OP.
 VIÐ ÚTVEGGI BEYGIST ANNAÐHVERT JÁRN UPP Í EFRI BRÚN PLOTU
 Í 55.CM FJARLÆGD FRÁ INNRI BRÚN VEGGS.
 BIL MILLI JÁRNA ERU GEFIN Í CM MILLI JÁRNAMÍÐJA.
 BLONDUN STEYPU: SEMENTSMAGN Í STEYPU SÉ Í VEGGJUM 250.KG/M³ EN
 Í PLOTU SÉU 300.KG/M³. NOTA SKAL LOFTBLENDI OG VIBRERA STEYPUNA.
 SIGMÁL STEYPU SÉ 6-8.CM .

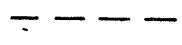
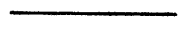
MERKINGAR:

-  MERKIR MÆSTA JÁRNLAG Í PLOTU IEGGIST SAMSIÐA MERKI
-  UPPFEYGGJUR BYRJA.
-  JÁRN Í NEÐRI BRÚN PLOTU
-  JÁRN Í EFRI BRÚN PLOTU.
- TALA Í HRING MERKIR PLOTUÞYKKT Í CM.

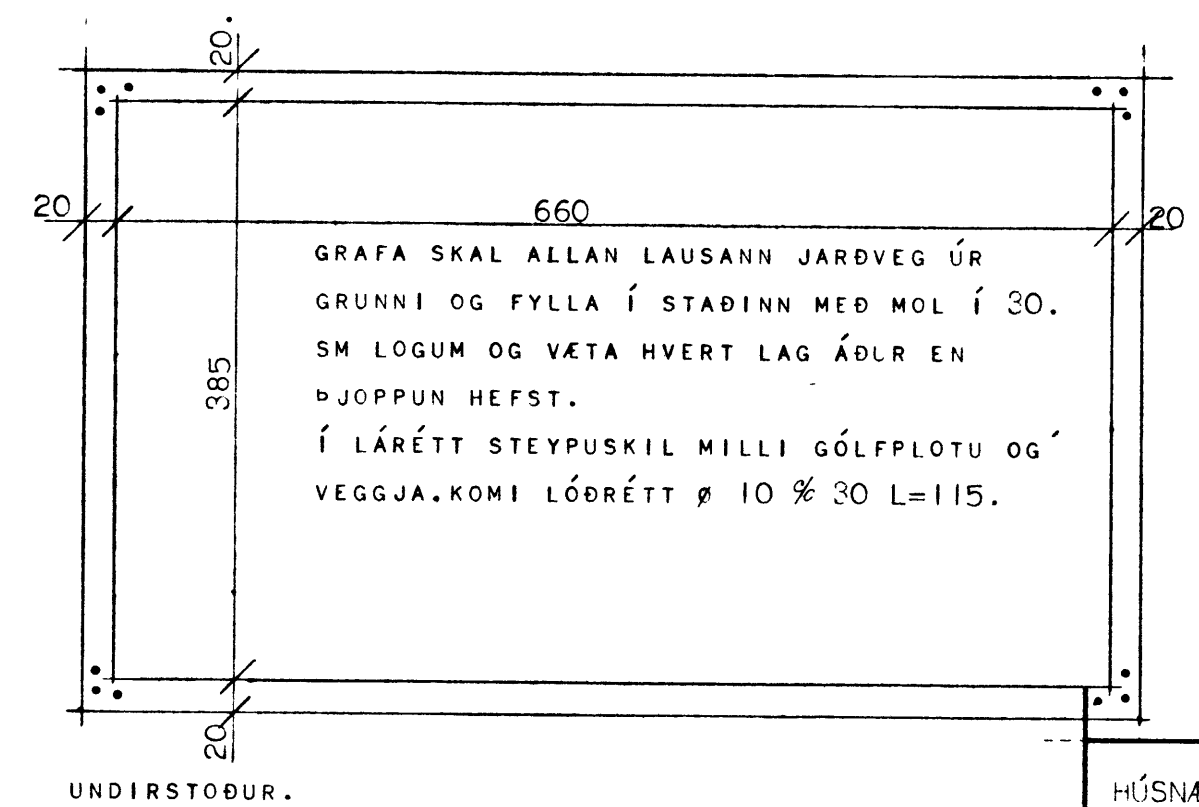
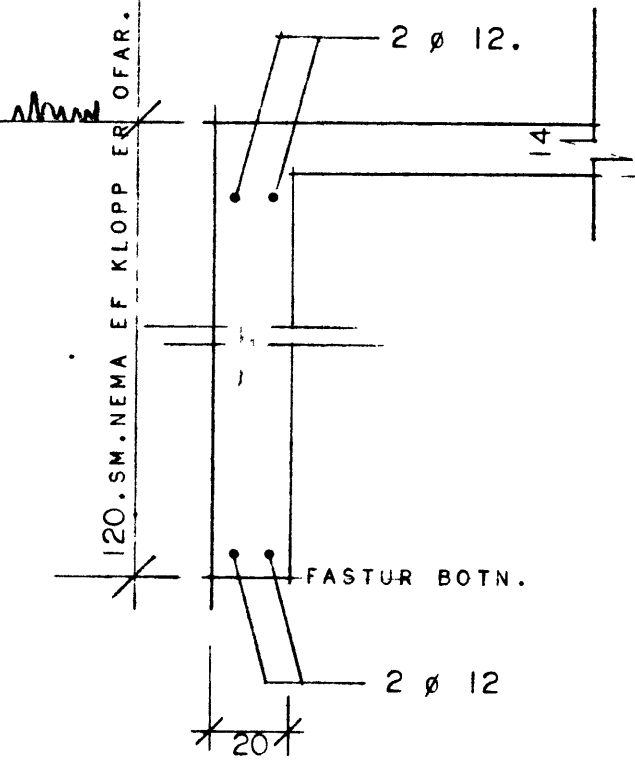
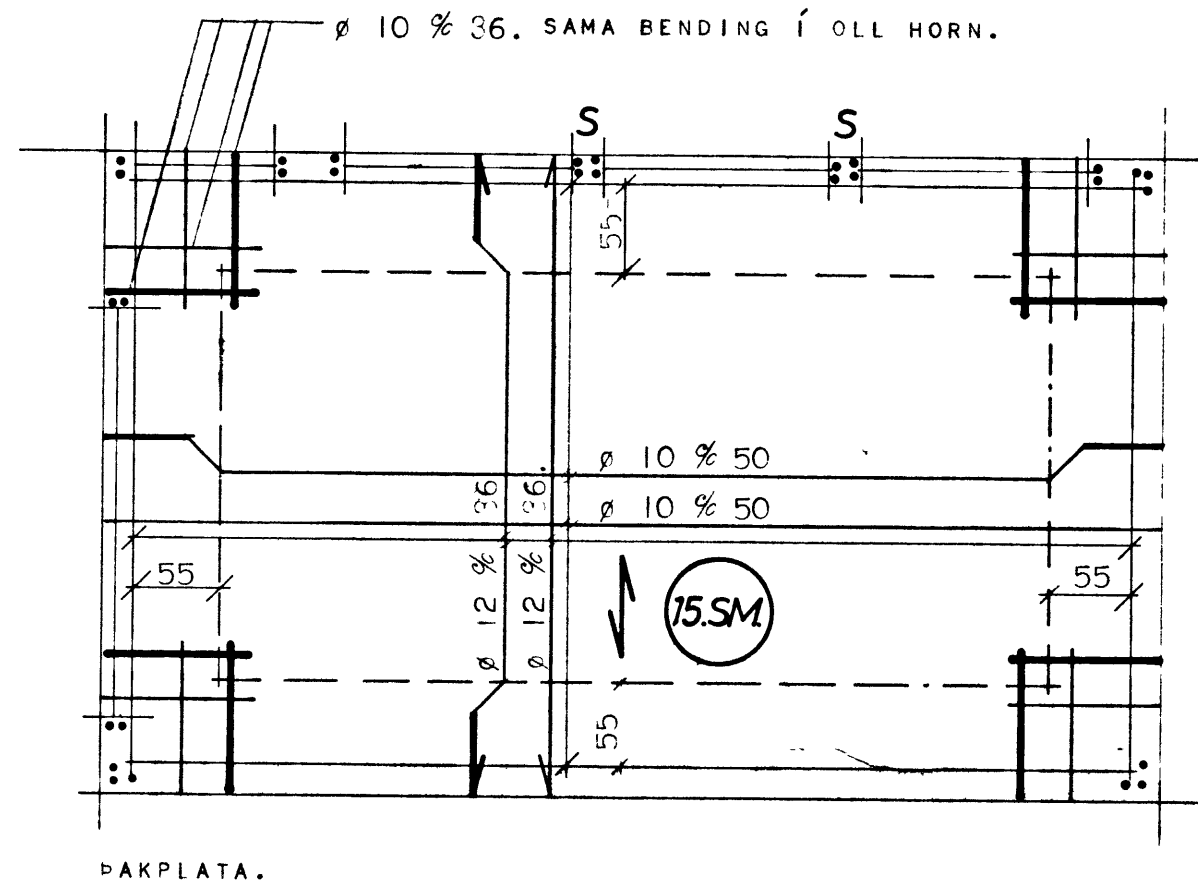
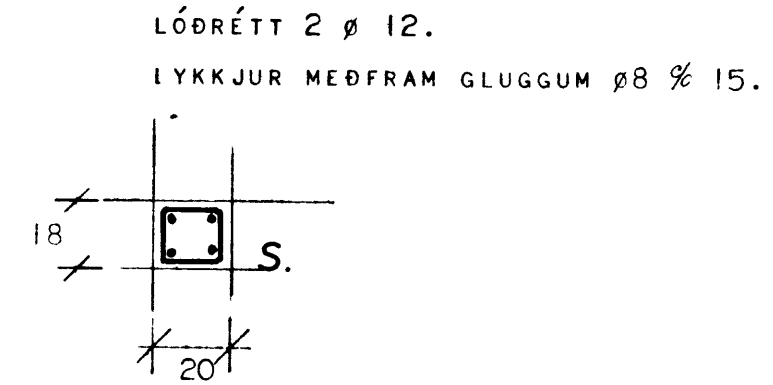
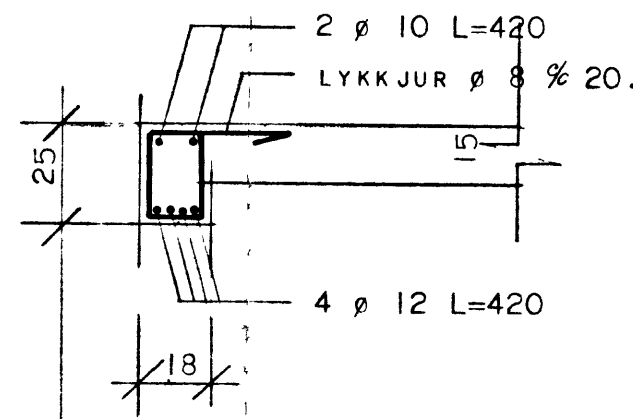

| | |
|-------------------------------|--|
| HÚSNÆÐISMÁLASTOFNUN RÍKISINS. | |
| JÁRNLENT STEYPA | SÉRTEIKNING VERK NR. 78. SEPT 1970 MK 1:50. |

S. J. ÞK 11