

SAMÞYKKT AF BYGGINGARFULLTRÚA

13. MAÍ 2019

BYGGINGARULLTRÚN Í VESTMANNNAEYJUM

UNDIRRITUN SAMRÆMINGARHÖNNUÐAR

*Tybjörgun Þórguðsson 270613-544*

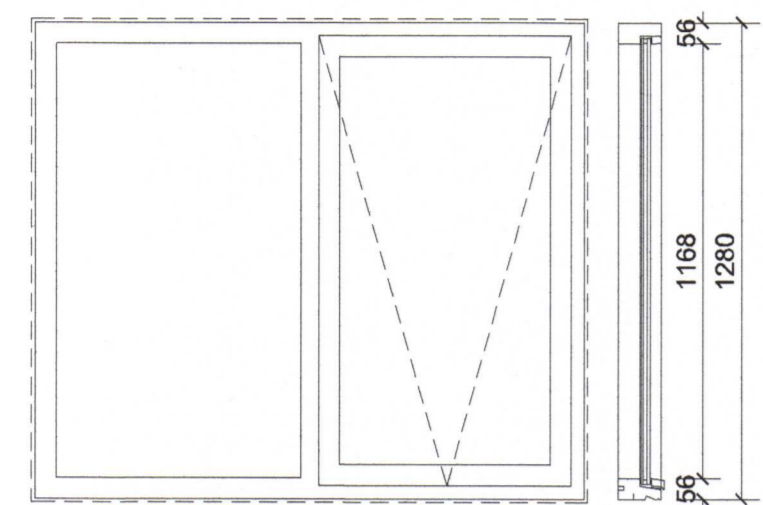

G-1 = 7 STK.

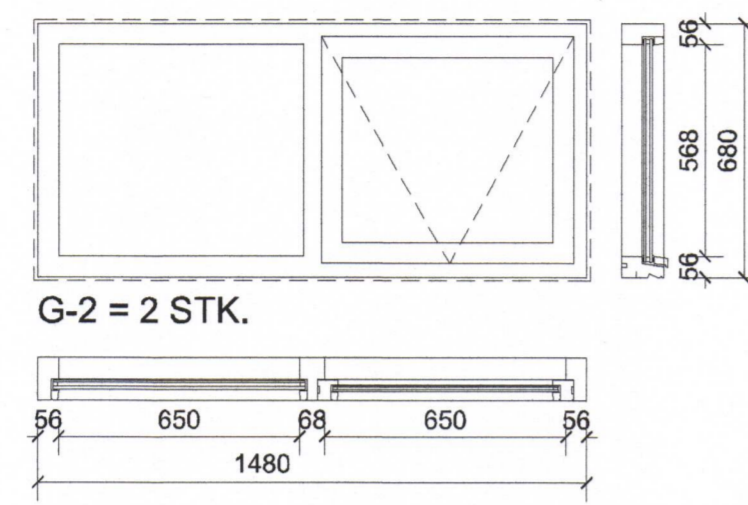
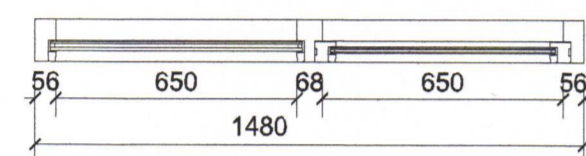

G-2 = 2 STK.

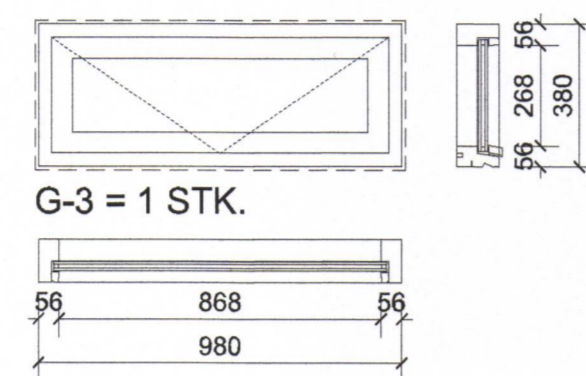
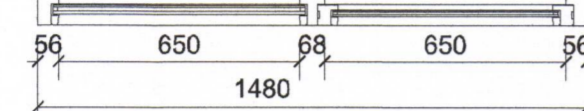

G-3 = 1 STK.

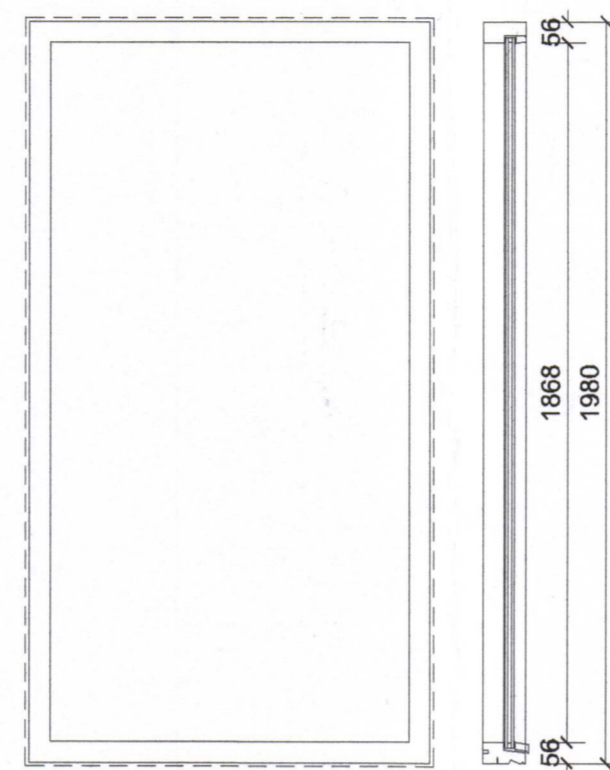
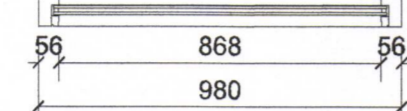

G-4 / 1 STK.

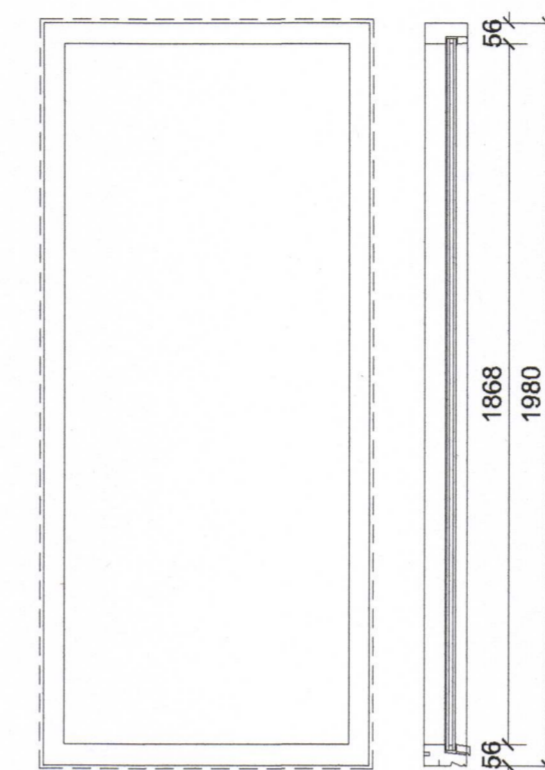
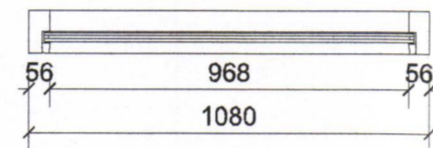

G-5 / 2 STK.

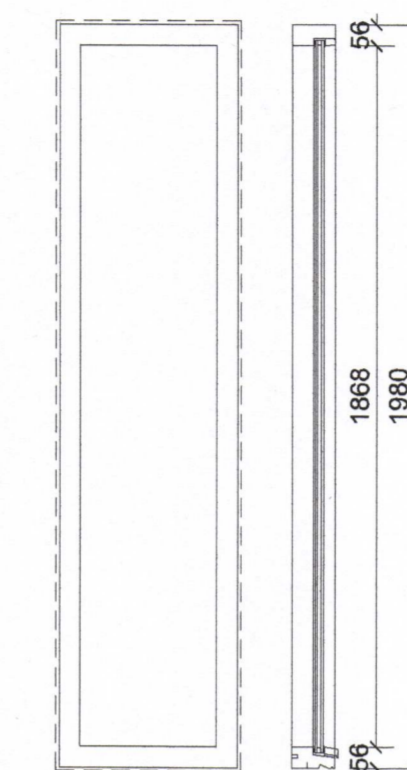
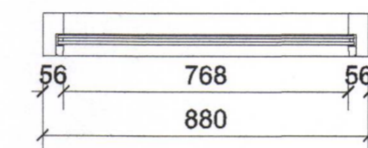

G-6 / 1 STK.

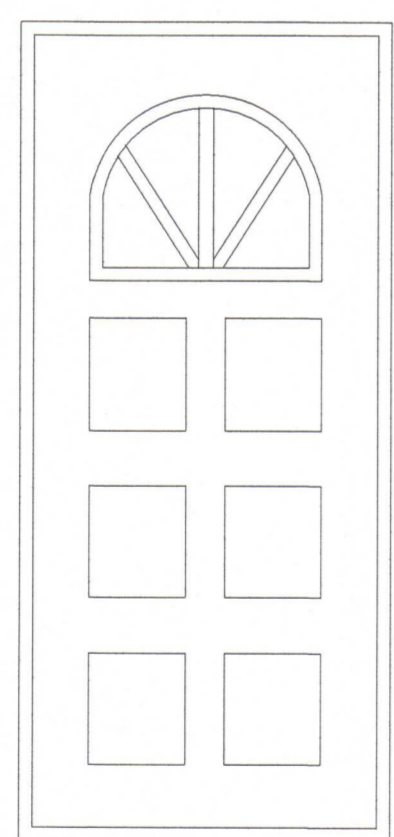
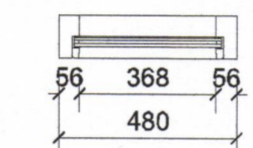

H-1 = 3 STK.

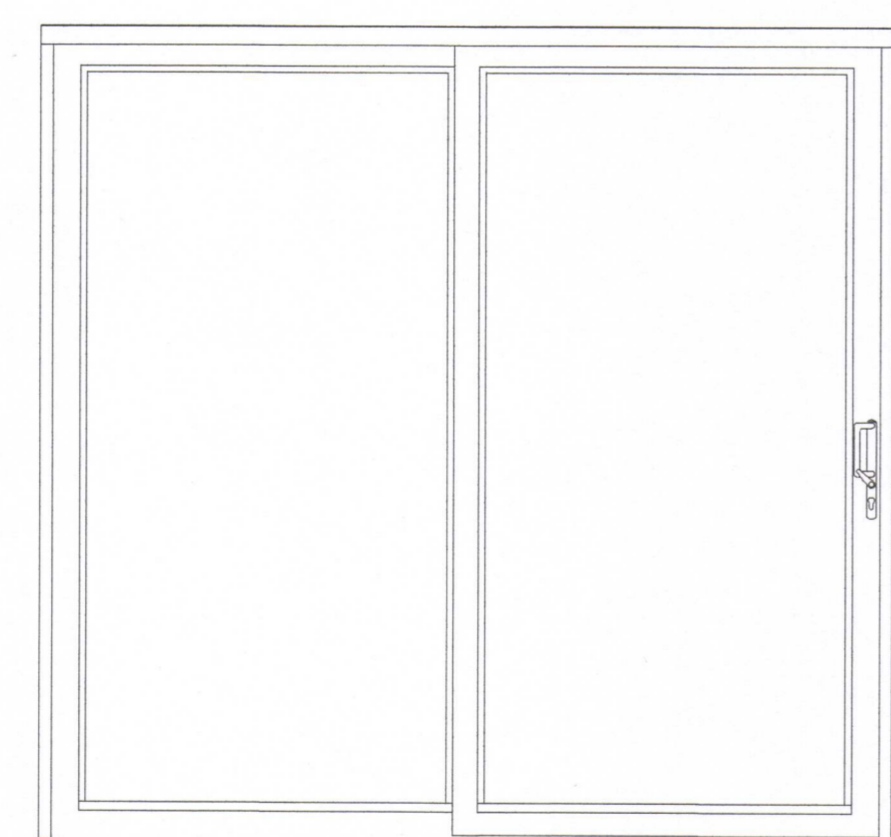
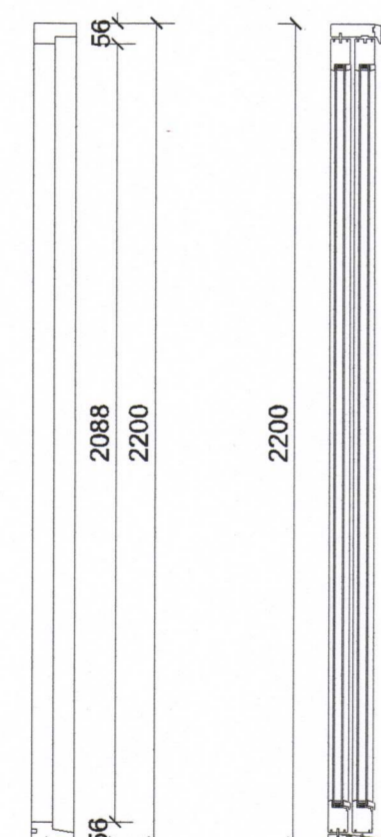
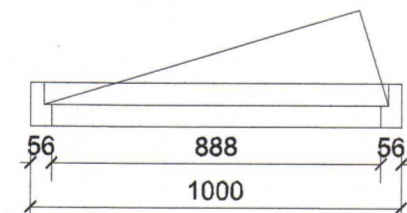

H-2 = 1 STK.

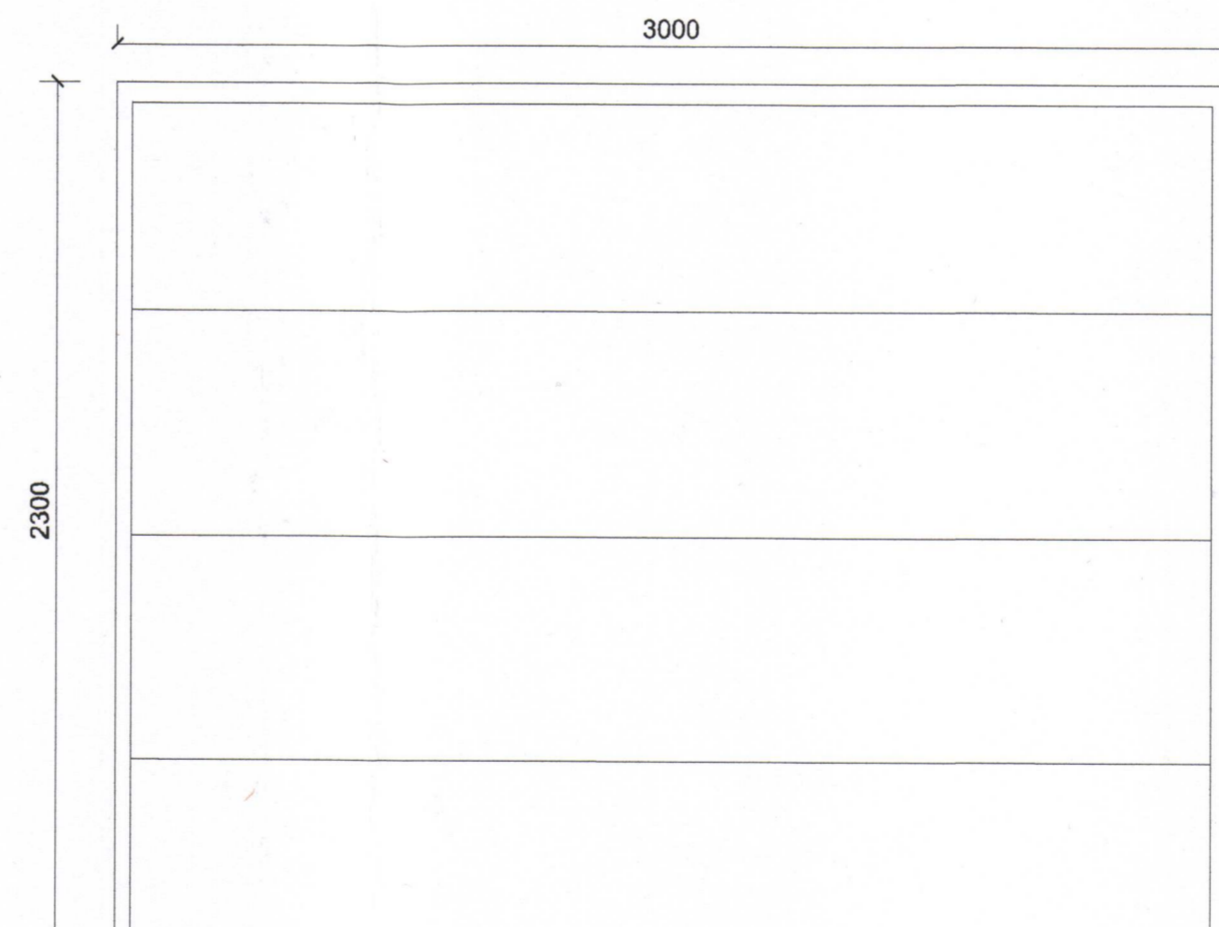
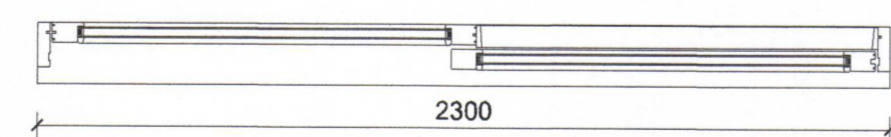

H-3 = 1 STK.

TILVÍSUN

ÚTG. DAGS SKYRINGAR TEIKNAN RÝNT SAMÞ

**tpz** teiknistofa

Kirkjuvegi 23 900 Vestmannaeyjum Sími 481-2711 tpz@teiknistofa.is www.teiknistofa.is

ÚTG. DAGS	HANNAD	MÆLIKVARÐI
17.09.2018	RS/BB	1:20 (A1)
YFIRFARID	TEIKNAD	1:40 (A3)
BB	RS/BB	

SAMÞYKKT: *Tybjörgun Þórguðsson 270613-544*

GODAHRAUN 10  
 900 VESTMANNNAEYJAR  
 ADALUPPDRETTIR - HLUTATEIKNING  
 GLUGGAR OG HURÐAR  
 GRUNNMYND