

1 2 3 4 5 6 7 8 9 10 11 12

SAMÞYKKT AF BYGGINGARFULLTRÚA
13. MAR. 2018
BYGGINGARFULLTRÚINN Í VESTMANNAEYJUM

UNDIRRITUN SAMRÆMINGARHÖNNUDAR

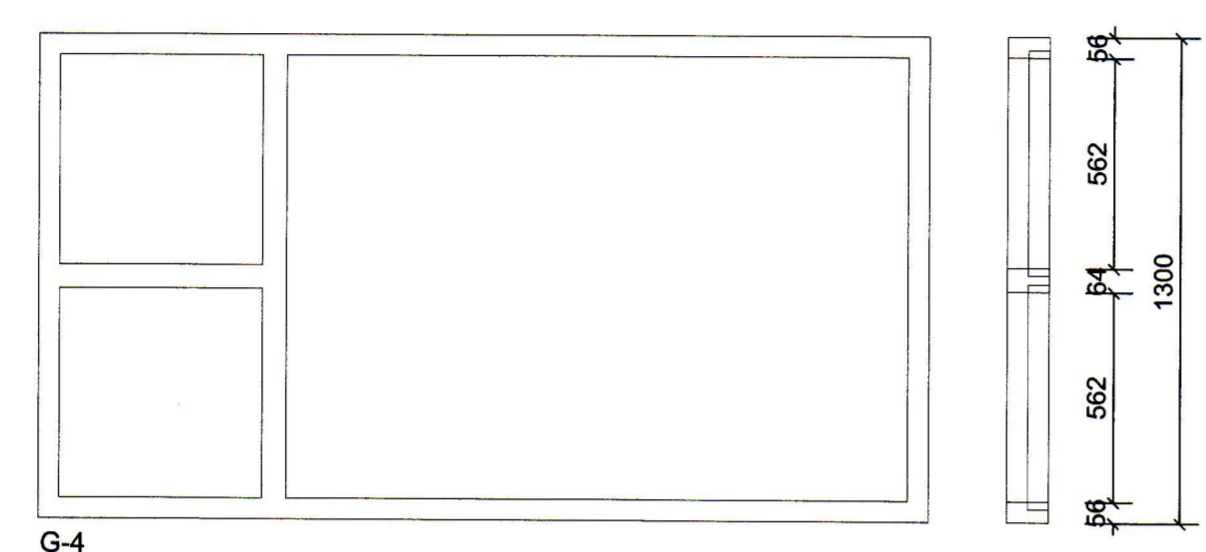

G-4

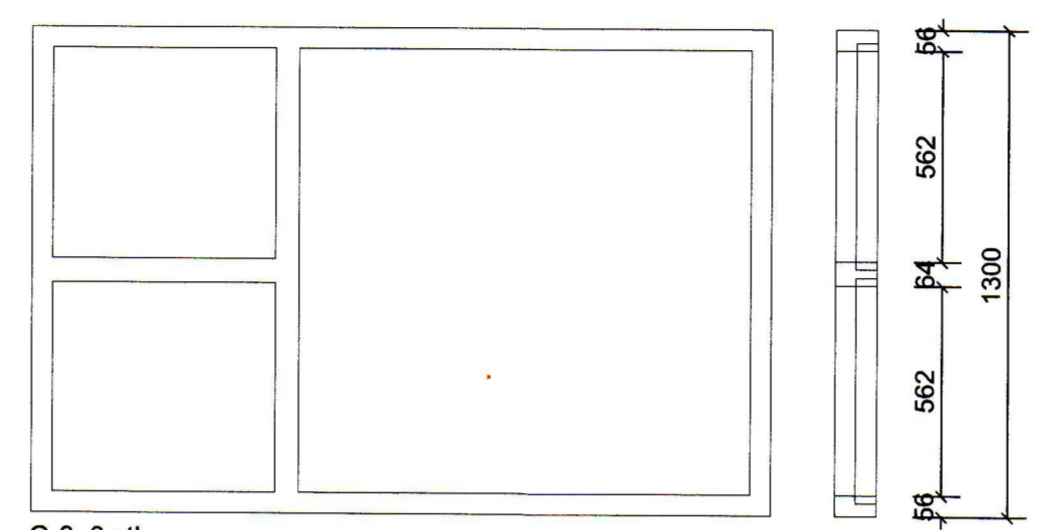
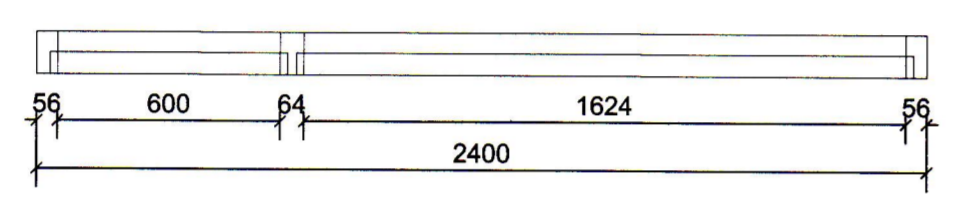

G-3 3 stk

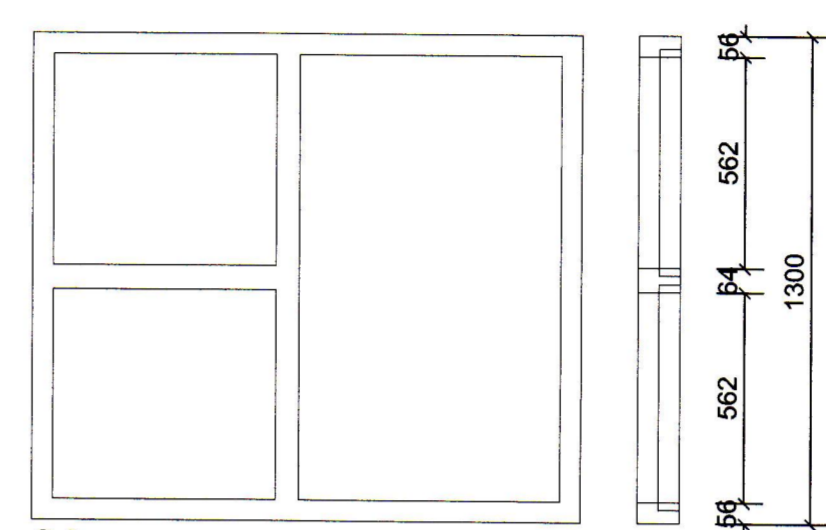
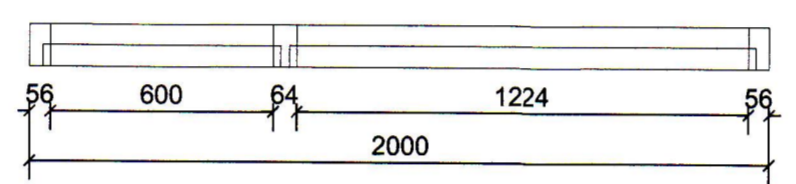

G-2

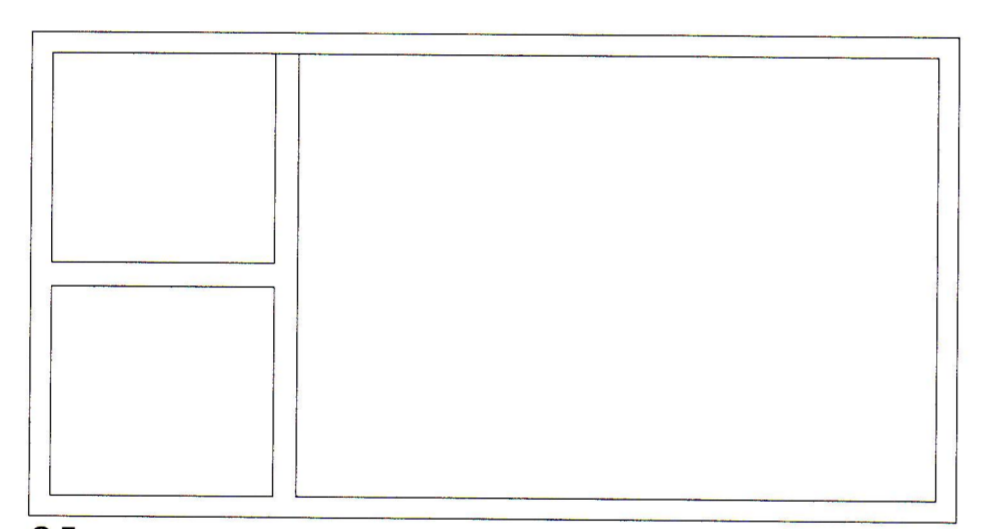
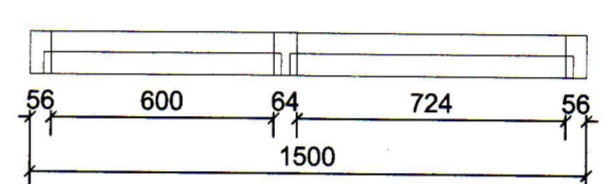

G-7

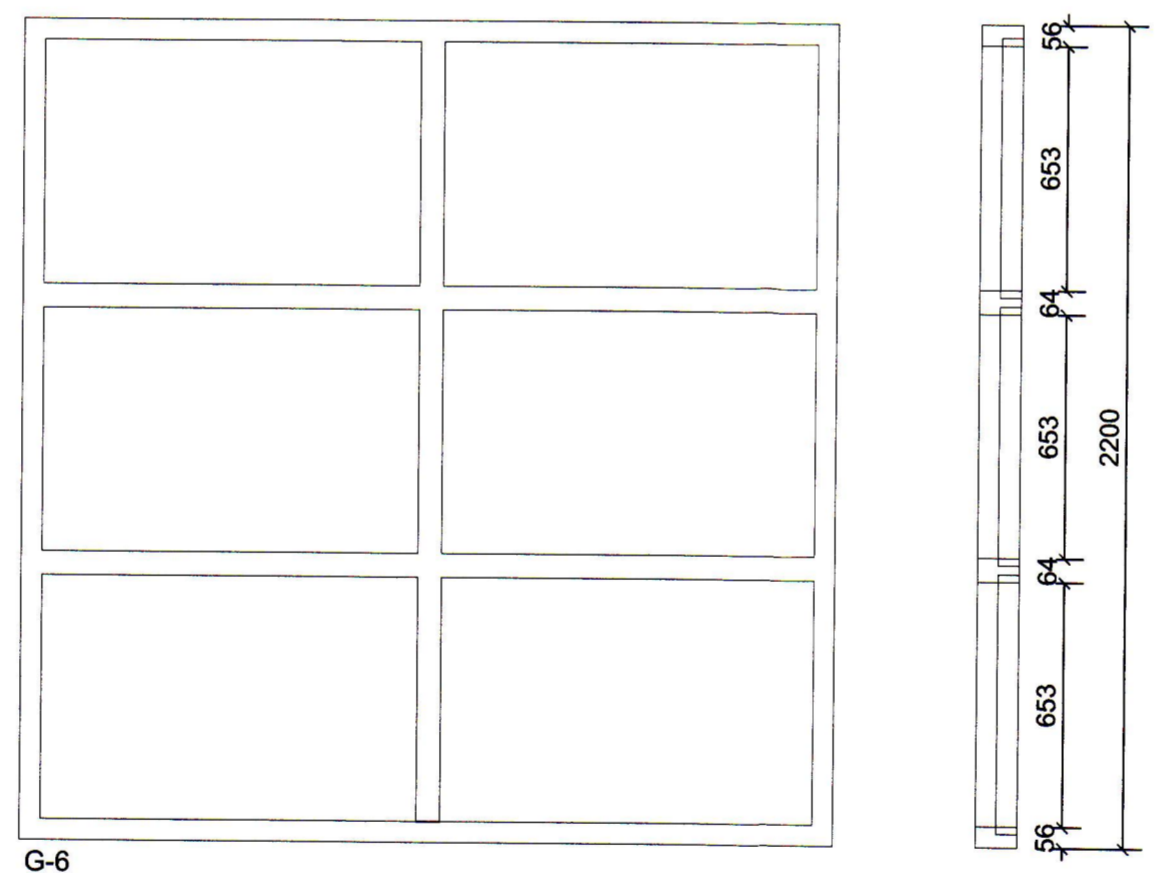
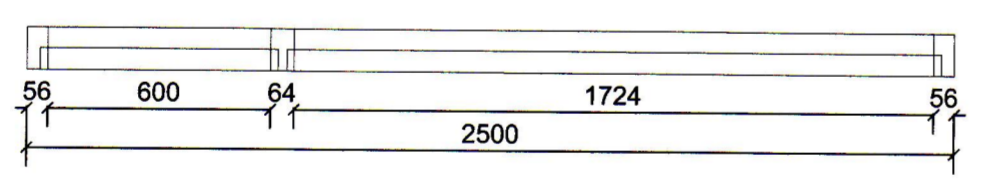

G-6

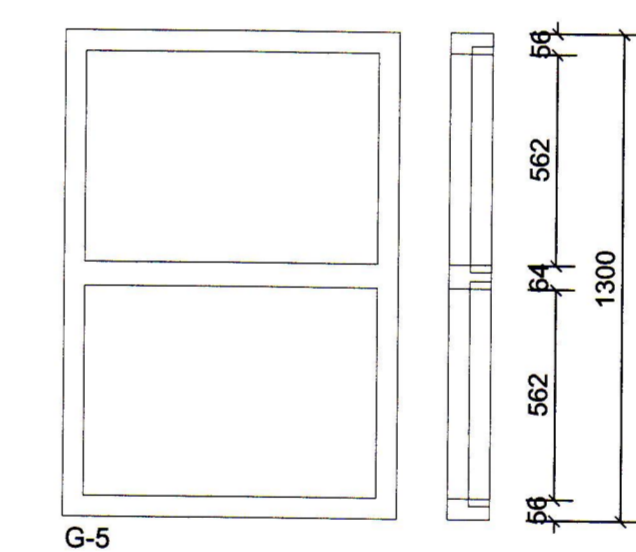
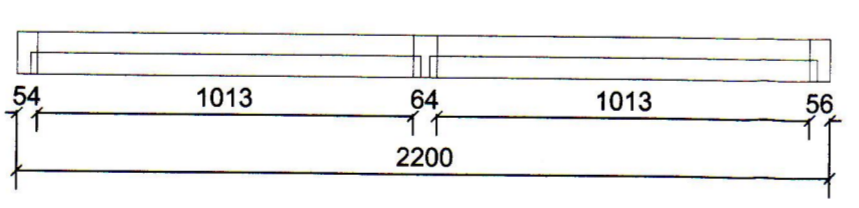

G-5

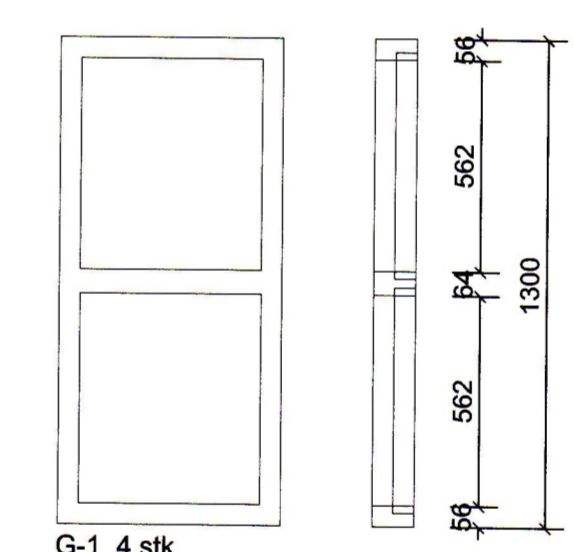
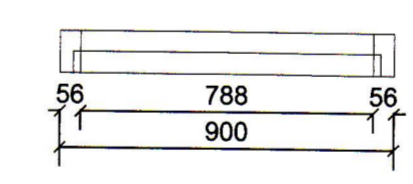

G-1 4 stk

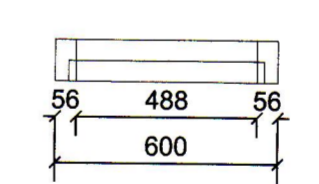

TILVÍSUN

BREYTING: A-BJÖRGUNAROP

ÚTG. DAGS SKÝRINGAR TEIKN. HANN. RYNT. SAMÞ.

tpz Kirkjuvegi 23 900 Vestmannaeyjum
 Simi 481-2711 tpz@teiknistofa.is www.teiknistofa.is
teiknistofa

| | | |
|-----------------------|----------------|-------------------------|
| ÚTG. DAGS 19.02.18 | HANNAÐ SP | MÆLIKVARÐI 1:20 (A1) |
| YFIRFARIÐ SP | TEIKNAD SGS | |

SAMÞYKKT: *Signature* 216259-2339

GERÐISBRAUT 6
900 VESTMANNAEYJUM
GLUGGAR

©Örskot og skrifin teikningar, að hluta eða í heild er háð skriflegu leyfi höfundar